

# ROBAM

Edition: A/2

Publication Date: November, 10, 2025

# ROBAM

香港總代理

嘉榮電器貿易有限公司

荃灣沙咀道57號荃運工業中心二期2樓G室 電話2421 1210

Hong Kong Sole Distributor

Kelvin Electric Trading Co., Ltd

2G, Superluck Industrial CTR (Phase 2)

57 Sha Tsui Road, Tsuen Wan, N, TTel 2421 1210

**HANGZHOU ROBAM APPLIANCES CO.,LTD.**

No.592,Linping Av., Linping Economic Development Zone, Linping District, 311100, Hangzhou, Zhejiang Province P.R.China

中國浙江省杭州市臨平區臨平經濟開發區臨平大道592號 郵編: 311100

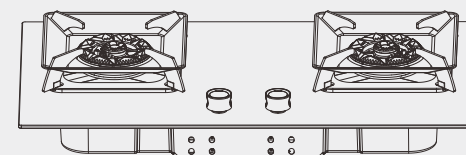

## User & Installation Manual

Before operating this unit, please read the user manual completely and keep it. If the manual is lost, you can send e-mail to [overseas@robam.com](mailto:overseas@robam.com), request for an electronic manual.

Hong Kong Sole Distributor

Kelvin Electric Trading Co., Ltd

2G, Superluck Industrial CTR (Phase 2)

57 Sha Tsui Road, Tsuen Wan, N, TTel 2421 1210

## **JZR-9B5H01**

### Gas Hob

---

## Contents

---

Safety Precautions .....	1
Product Structure .....	4
Accessories List .....	4
Product Parameter .....	5
Installation Instruction .....	6
Use Instruction .....	8
Clean and Maintenance .....	9
General Troubleshooting .....	10

## Safety Precautions

- ◆Attention! According to the Gas Safety Ordinance of Hong Kong, any gas installation works including the installation of appliances and connection tubing, must be undertaken by registered gas installers who are registered for that appropriate classes and be employed by registered gas contractors.
- ◆This cooktop DO NOT require EXTERNAL Gas Governor.
- ◆Never use aluminum tray.
- ◆Use approved gas tubing bearing EMSD approval marking (such as : 機電工程署批准EMSD APPROVAL GTXXXX) for connection to appliances, or other appropriate methods accepted by EMSD.
- ◆When gas leakage is suspected, close the valve of the gas source immediately, open the window and vent out any gas trapped in the room; do not use electric fan, hood and other electrical cooktop to discharge the gas; do not operate the switch of the electrical appliances and pay attention to the smoke and fire, and at the same time contact the aftersales service of the local branch office.
- ◆During operation, keep your body away from the burner. After use, always turn off the gas supply valve and ensure the control knob is in the OFF position to prevent accidents.
- ◆Do not use the cooktop for heating without a pan or with an empty pan. Doing so may cause damage to the range hood above the cooktop due to overheating, or may ignite the residual grease in the range hood and cause a fire accident.
- ◆Avoid covering the flame with a barrier, no flammable items should be placed around the cooktop, and the cooktop should not be used to dry towels or clothes.

- ◆Pan support, internal cap, external cap and other parts of the cooktop will still be very hot when in use or just after the flame is turned off, so please avoid touching them with your hands.
- ◆This cooktop should only be used in the home kitchen, do not use this cooktop in other situations (e.g., commercial use).
- ◆Do not operate the cooktop unattended, turn off the knob switch and the main gas valve after use, and double check to make sure it is turned off before leaving the cooktop.
- ◆If combustion occurs due to high oil temperature, immediately cover the fire source with a large metal object such as an iron pot lid to isolate the air needed for combustion, and then turn off the main indoor gas valve. Do not use water to extinguish the fire to prevent accidents.
- ◆Do not allow unsupervised young children or individuals with disabilities to operate this cooktop, and prohibit children from playing with the cooktop. Do not use the cooktop where the hands of young children can touch it, or it may cause burns or other accidental injuries.
- ◆Non-professionals should not install, disassemble the machine for repair or replacement of parts without authorization.
- ◆Before installation, please be sure to check whether the type of gas you are using is the same as that indicated on the nameplate of the cooktop; if it is not, installation and use are strictly prohibited.

- ◆Each ignition time of the cooktop must be less than 20 seconds to avoid deflagration; if the cooktop fails to ignite for 5 consecutive times, please contact the local after-sales service point immediately.
- ◆The cooktop will become hot during use, avoid touching the heating unit after operation. Metal objects such as knives, forks and lids should not be placed on or near the cooktop glass surface as they may become hot.
- ◆The gas cooktop should be installed in a well-ventilated area, but should be shielded from strong direct winds.
- ◆If you hear "whirring ....." during use or ignition, or if the burner backfires during use or ignition, immediately turn off the cooktop; only after the cooktop has cooled down completely, check whether the internal cap, external cap and flame spreader are placed correctly, and then relight the cooktop after adjustments.
- ◆The cooktop will produce exhaust gas emission during combustion, so for the safety of use, please use it under ventilated or hooded working condition.
- ◆Don't hit the cooktop panel with force or hard objects, and hold it gently when carrying and installing to avoid damaging the cooktop panel.
- ◆During the combustion process of the cooktop, especially in the small flame state, drafts from opening the cabinet door quickly may cause the flame to go out, if needed, please open the cabinet door slowly during operation.
- ◆Gas supply tube need to be fixed to ensure unobstructed routing inside the cabinetry and do not cause interference with others.

## Product Structure

※The pictures in this manual are schematic drawings for reference only. If the pictures do not match the actual product, the actual product shall prevail. The appearance and structure of the company's products are constantly being improved, and the contents of the products are subject to change without prior notice.

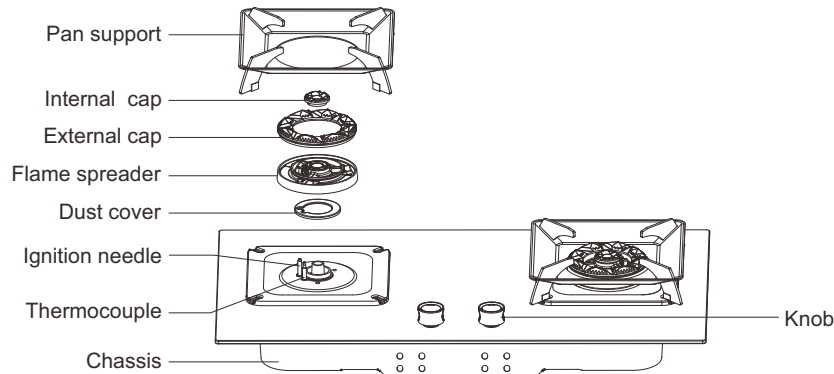

## Accessories List

- 1. One copy of the instruction manual
- 2. One battery (in packing foam)
- 3. One 2-in-1 wok rack
- 4. One set of limiters
- 5. One set of plastic gasket

### Cookware Size Limit

Do NOT use any over-sized flat based cookware, to avoid burns due to high heat and impacts to the cookware life expectancy. When using small-sized cook wares, please adjust flame to lower accordingly, to avoid flames from exceeding the base of the cookware.

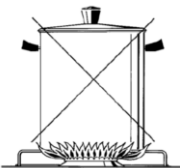
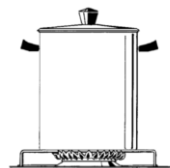
		Burner	Maximum flat base cookware diameter (mm)
		Left	300
Right	300		

## Product Parameter

Model	JZR-9B5H01
Type of Gas	HK town gas
Gas Pressure	1.5kPa
Rated heat input	Left:5.2kW      Right:5.2kW
Gas Connection	G1/2 inch B.S.P (Male)
Product Size	(780×450×130)mm
Net Weight	14kg
Hob Element Number	2
Surface	Tempered Glass
Size Of Opennings	(650×350×R10)mm
Ignition Method	Pulse

Note:

- The parameters in the table are for reference only, the specific data are subject to the nameplate on the cooktop;
- The Company reserves the right to change product design and specifications.
- When this cooktop is installed brand new, the recommended opening size is (650×350)mm see point 6 of the installation instructions; if it is installed as a replacement, it can be adapted to the opening size range of (650~710)mm×(350~400)mm see point 7 of the installation instructions.

## Installation Instruction

1. Use approved gas tubing bearing EMSD approval marking (such as : 機電工程署 批准EMSD APPROVAL GTXXXX) for connection to appliances, or other appropriate methods accepted by EMSD.
2. When the cooktop is installed, the distance between the surrounding area and combustible materials should not be less than 15 centimeters, and the distance between the surrounding area and non-combustible materials should not be less than 7 centimeters; the cooktop should have a height of 100 centimeters or more to the objects above it, and if a cooktop hood is installed, a height of 65 centimeters-75 centimeters to the surface of the cooktop is preferable (set up the space in accordance with the requirements for the installation of the cooker hood).
3. The cabinet in which the built-in cooktop is installed should have an opening size (area of not less than 100 square centimetres) to the atmosphere that meets the ventilation requirements, otherwise it will result in the accumulation of leaking gas and cause an explosion.
4. Gas connector is G1/2 B.S.P (Male) to be connected with EMSD APPROVAL GTXXXX gas tubing ONLY, the plastic gasket should be placed inside nut before being tightened, leakage should be checked, and no leakage should be detected before use.(As shown in Pic1)

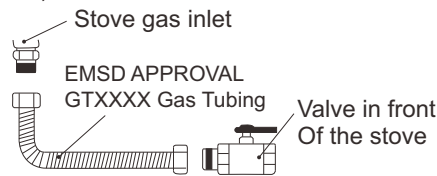

Pic1

5. When installing the dust cover, internal cap, external cap, flame spreader, pan support, please follow the diagrams, all parts must be placed smoothly without offsetting and tilting. After installation, check to make sure they are in place. If parts are to be removed, do so in reverse order.

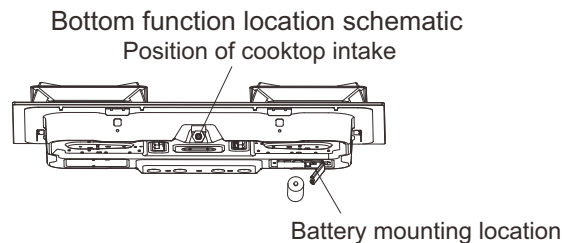
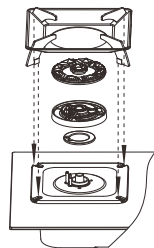

6. Recommended openings for brand new installation of this cooktop 650mm x 350mm. The cooktop needs to be installed on a sturdy, level cabinet countertop, and the holes should be made according to the dimensional requirements shown in the drawings, and the cooktop should be embedded in the holes and leveled.

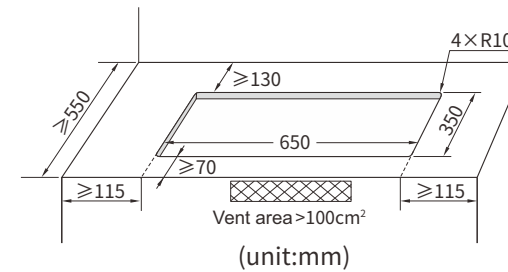

7. For replacement installation of this cooktop, please refer to the following method. Applicable opening range of this cooktop: (650~710)mm x (350~400)mm. If replacing the installation, install as follows.

- ① Measure the actual size of the opening in the user's home by the installer (minimum opening 650mm x 350mm);
- ② Symmetrically stretch both sides of the adjusting lever to the desired position as shown in the figure (4mm interval for each position), adjust the rear side in the same way, and put the chassis into the cabinet hole to complete the installation;
- ③ If you need to adjust the narrowing, press the limit switch on the adjusting seat by hand and push in the adjusting lever.

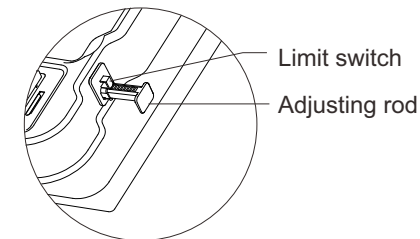

## Use Instruction

1. Check that the internal cap, external cap, flame spreader, pan support, etc. are in place; confirm the position of the knob switch (Pic2), and then turn on the gas supply valve.
2. Ignition method: press the knob switch, counterclockwise rotation of 90 degrees is high power (Pic3), at this time you will hear a continuous "pop" pulse ignition sound, the knob can be released after ignition; if ignition is successful, you can now enjoy cooking on your cooktop; if ignition has failed, repeat the above operation. Rotate counterclockwise and then rotate 90 degrees will be a low power flame (Pic4).

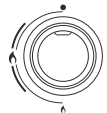

Pic2



Pic3



Pic4

NOTE: When using for the first time or if the cooktop has been out of use for a long time, the first ignition may not ignite due to the presence of air in the piping, so the operation needs to be repeated.

3. Flame failure operation: Turn the knob switch clockwise to (Pic2) position, the fire will be extinguished.
4. Adjustment of fire power: Rotate the knob switch according to the fire power indication corresponding to the knob switch to obtain the corresponding fire power.
5. This safety device can protect accidental extinguish of flame due to wind or water but it cannot protect all kinds of gas leakage conditions, The gas valve will close in 10-30 seconds. Adjust the flame controller to "OFF" (Pic 2) as soon as possible even the flame failure protection device is functioned. After-ignite after the gas dispersed, Please do not totally rely on the flame failure protection device

## Clean and Maintenance

1. Care of the surface of the cooktop: please use a neutral detergent-soaked cloth to wipe, and then wipe with a dry cloth, do not use a steel wire brush or other hard objects to clean.
2. In order to keep the stove in normal use and good combustion state, must often use the brush and steel needle to dredge the thru hole (groove), remove the dirt on the flame spreader, internal and external cap, so as to avoid the thru hole (groove) clogged and cause backfire and damage to the stove, do not use water to wash.
3. Always check whether if the internal cap, external cap and flame spreader, etc. are shifted or deviated; if so, it must be corrected (must be placed in correct place) to avoid accidents.

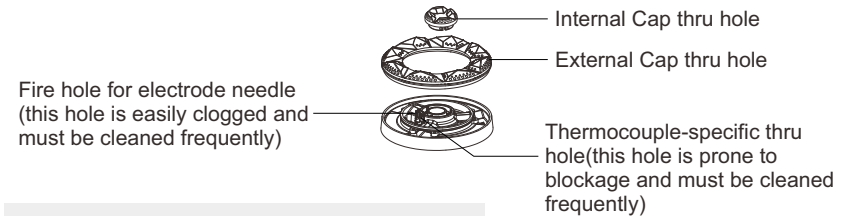

### Environmental Impact Statement for Users

1. Please dispose of the dry cell batteries used in the product properly after the power is exhausted to avoid pollution to the environment.
2. This product uses packaging materials that are suitable for the environment and easy to recycle. Please dispose of packaging materials responsibly to save raw materials and reduce waste.
3. Do not allow children to play with packaging materials such as plastic film, cardboard boxes, etc. This may result in choking accidents, so keep packaging materials away from children.

## General Troubleshooting

Problem	Possible Reason	Measurement
Ignition Failure	Gas Valve is not open	Turn off the control switch Then turn on the gas valve
	Air exists in gas pipe	Exhaust the air by igniting repeatedly
	Electrode needle is dirty	Clean electrode needle
	Ignitor malfunction or the electrode needle in wrong position	Adjust the electrode needle to burner, keep the distance 4mm
	Without battery, put battery oppositely or power insufficiency	Install the battery collectly or replace the battery
The burner is not work when loosen the knob	Internal cap, external cap and flame spreader not in position	Internal cap, external cap and flame spreader must be placed in correctly
	Knob not pressed	Press the knob firmly (to the bottom) and release it
Burning abnormal or sounding noise	Burner is blocked	Clear away the blockage
	Any other Burning Abnormal, or sounding noise	Contact Hong Kong Sole Distributor, to arrange for certified personal to inspect

### Service

Should there be any problem with the cooking hob, or burning abnormality, or fault, It is recommended to stop using the product, and contact Hong Kong Sole Distributor to arrange for inspection by registered gas installers who are registered for that appropriate classes and be employed by registered gas contractors.

Hong Kong Sole Distrubutor  
Kelvin Electric Trading Co., Ltd  
2G, Superluck Industrial CTR (Phase 2)  
57 Sha Tsui Road, Tsuen Wan, N,T  
Tel 2421 1210

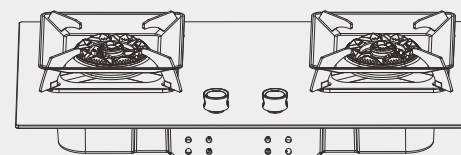

## 使用及安裝 說明書

使用產品前請仔細閱讀本使用說明書，並妥善保管。如果說明書丟失，您可以發送郵件至 [overseas@robam.com](mailto:overseas@robam.com)，獲取電子版說明書。

香港總代理  
嘉榮電器貿易有限公司  
荃灣沙咀道57號荃運工業中心二期2樓G室 電話2421 1210

**JZR-9B5H01**

嵌入式家用燃氣爐

## 目 錄

安全注意事項 .....	13
產品結構 .....	15
附件清单 .....	15
產品性能參數 .....	16
安裝說明 .....	17
使用方法 .....	18
清掃維護注意事項 .....	19
常見故障及處理方法 .....	20

## 安全注意事項

◆注意：根據香港氣體安全條例，任何氣體裝置工程，包括爐具和接駁喉管的安裝，必須由註冊氣體裝置技工執行，而該技工已於相關的氣體工程類別註冊及受聘於註冊氣體工程承辦商。

◆此爐具不需要外置穩壓器。

◆禁止使用錫紙爐碟。

◆使用認可印有機電工程署批准標記 (例如：機電工程署批准 EMSD APPROVAL GTXXXX) 的氣體接駁喉管連接爐具，或使用機電工程署接納的其他恰當方法。

◆當發現爐具漏氣時，應立即關閉氣源閥門，打開窗戶，疏通室內空氣；不得使用電風扇、吸油煙機等電器排出氣體；不得操作電器開關，並注意煙火，同時與當地售後服務點聯繫。

◆點火操作時，人體要遠離燃燒器；使用完畢，請務必關閉氣源閥門及爐具旋鈕開關，以免意外事故的發生。

◆請勿在不放鍋或空鍋狀態下，使用爐具進行加熱。如此操作可能導致爐具上部的吸油煙機因過熱而損壞，或可能點燃吸油煙機的剩餘油脂而發生火災事故。

◆避免用阻隔板掩蓋火焰，爐具周圍不得放置易燃物品，爐具不可用來烘乾毛巾、衣物等。

◆使用中或剛熄火後，鍋架、銅蓋、銅芯、銅燃燒器、面板等部位仍會很燙，請避免用手觸摸。

◆該爐具只能用於家庭廚房，請勿在其它場合（如：商業用途）使用該爐具。

◆不可在無人監管下使用該爐具，使用後關閉旋鈕開關及燃氣總閥門，離開前重複檢查是否關好。

- ◆如因油溫過高等而發生燃燒時，請立即用鐵鍋蓋等大面積的金屬物蓋住火源，以隔斷燃燒所需空氣，再關閉室內燃氣總閥門。請勿用水來滅火，以防意外發生。
- ◆禁止無人照看的幼兒和殘疾人使用此器具，並禁止兒童玩耍器具。更不要放在幼兒的手可以觸摸到的地方使用，否則有可能導致燙傷或別的意外傷害。
- ◆非專業人員不得擅自安裝、拆機修理或更換零件。
- ◆安裝前請務必核對您所使用的燃氣種類是否與爐具銘牌上所標注的一致；若不一致嚴禁安裝及使用。
- ◆爐具每次點火時間必須小於20秒，以免爆燃；連續點火5次不能點燃時，必須與代理商安排檢查。
- ◆爐具在使用期間會發熱，注意避免接觸發熱單元。金屬物體如刀、叉和蓋不應放在爐臺上，因為它們可能變熱。
- ◆燃氣爐應安裝在通風良好的地方，但應避免強風直吹。
- ◆若在使用中或點火時，聽到“呼呼.....”燃燒器發生回火，應立即關閉爐具旋鈕開關；在確保爐具是在冷卻狀態下；檢查銅蓋、銅芯及銅燃燒器等是否放置到位後再重新點燃。
- ◆爐具在燃燒過程中，會產生廢氣排放，為了使用安全，請在通風或吸油煙機工作狀態下使用。
- ◆不可用力或硬物敲擊爐具面板，在搬運、安裝時要輕拿輕放，以免損壞爐具面板。
- ◆爐具在燃燒過程中，特別是小火狀態，快速打開櫥櫃門有機會導致爐具熄火，使用時如有需要，請緩慢打開櫥櫃門。
- ◆氣管需進行固定，確保氣管與櫃內其他物品保留空間，避免碰撞。

## 產品結構

※本說明書中的圖片為示意圖，僅供參考，若圖片與實物不符，以實物為準。本公司產品外觀結構不斷改進，對於產品改進所引起的內容更改，恕不另行通知。

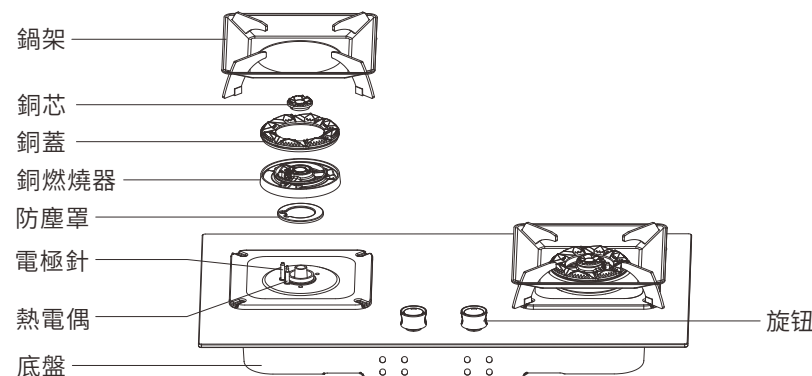

## 附件清單

1. 說明書一份
2. 電池一節(在包裝泡沫中)
3. 二合一炒菜鍋架一個
4. 限位件一套
5. 橡膠墊片一套

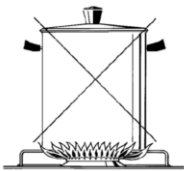
爐頭使用鍋具範圍							
切勿使用直徑過大的平底煮食鍋具，避免溫度過高而造成燙傷及影響具的使用壽命。使用細小鍋具時，請將火力調低，避免火焰超出鍋具底部。							
	<table border="1"> <thead> <tr> <th>爐頭</th> <th>最大平底煮食具直徑(毫米)</th> </tr> </thead> <tbody> <tr> <td>左爐頭</td> <td>300</td> </tr> <tr> <td>右爐頭</td> <td>300</td> </tr> </tbody> </table>	爐頭	最大平底煮食具直徑(毫米)	左爐頭	300	右爐頭	300
爐頭	最大平底煮食具直徑(毫米)						
左爐頭	300						
右爐頭	300						

## 產品性能參數

型號	JZR-9B5H01
氣體種類	香港煤氣
氣體壓力	1.5kPa
額定熱負荷	左:5.2kW 右:5.2kW
氣體接駁	G1/2英制陽螺紋
外形尺寸	(780×450×130)mm
淨重	14kg
爐眼數	2
爐面	鋼化玻璃
嵌裝開孔尺寸	(650×350×R10)mm
點火方式	電子脈衝式

注：

1. 表中參數僅供參考，具體資料以爐具上銘牌為準；
2. 本公司保留更改產品設計與規格的權利；
3. 本爐具全新安裝時，建議開孔尺寸為(650×350)mm詳見安裝說明第6點；若做替換安裝，可適應開孔尺寸範圍為：(650~710)mm×(400~350)mm詳見安裝說明第7點。

## 安裝說明

1. 使用認可印有機電工程署批准標記(例如:機電工程署批准EMSD APPROVAL GTXXXX)的氣體接駁喉管連接爐具，或使用機電工程署接納的其他恰當方法。
2. 爐具安裝時，四周與可燃物的距離不小於15cm，與非可燃物的距離不小於7cm；爐具與上方物件應有100cm以上的高度，若安裝吸油煙機，則距離爐面65cm-75cm的高度為宜（具體按吸油煙機的安裝要求設置此空間）。
3. 安裝嵌入式爐具的櫥櫃要有符合通風要求的與大氣相通的開孔尺寸（面積不小於100cm<sup>2</sup>），否則會造成洩漏燃氣積沉而引起爆炸。
4. 氣體接駁為G1/2英吋- 只可接上機電署批准的 GTXXXX 氣體接駁管，接駁位需要加入橡膠墊片後扭緊，並在使用前檢查清楚沒有任何漏氣，在沒漏氣情況下，方可使用。（如圖1）



圖1

5. 安裝防塵罩、銅燃燒器、銅蓋、銅芯、鍋架時，請按圖所示，所有零件必須放置平穩，不得偏移傾斜。安裝完畢後須檢查是否放置到位。若要拆下零件時，請按反向順序進行拆卸。

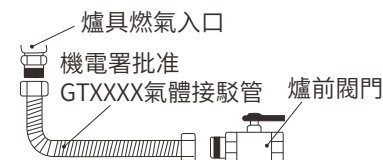
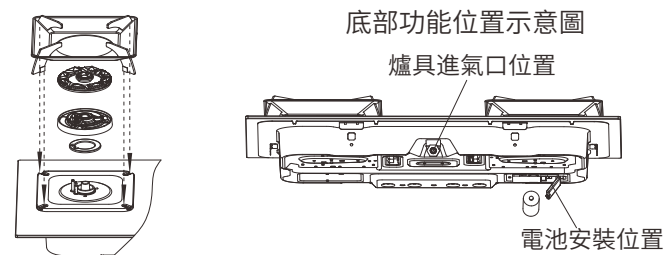

6. 本爐具全新安裝時，建議開孔650mm×350mm。

爐具需安裝在結實、水平的櫥櫃臺面上，應根據圖示尺寸要求進行開孔，把爐具嵌入孔內，平整即可。

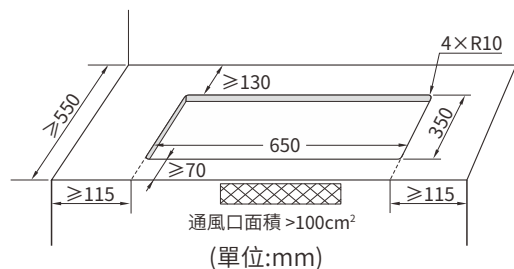

7. 本爐具若做替換安裝時，可參考以下方法。

本爐具可適應的開孔範圍為：(650~710)mm×(400~350)mm

若替換安裝，安裝方式如下：

- ①由安裝人員測量用戶家的開孔尺寸實際大小(最小開孔650mm×350mm)；
- ②按如圖所示將兩側的調節杆對稱拉伸至所需位置(每個檔位間隔4mm)，後側同理調節，將底盤放入至櫥櫃孔內完成安裝；
- ③如需調窄，用手按壓調節座上的限位開關，推入調節杆即可。

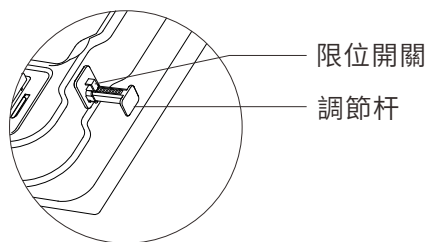

## 使用方法

1. 檢查銅蓋、銅芯、銅燃燒器、鍋架等放置是否到位；確認旋鈕開關(如圖2)的位置，然後開啟氣源閥門。
2. 點火方法：按壓旋鈕開關，逆時針旋轉90度是大火(如圖3)，此時會聽到連續“啪啪”脈衝點火聲，燃氣被點燃後即可鬆開旋鈕；若有火焰，即可放心使用；若無火焰，重複以上操作。逆時針再旋轉90度是小火(如圖4)。



圖2



圖3



圖4

注：初次使用或爐具停用過久，第一次點火可能未點燃，因管路內存在空氣，故需反復操作。

3. 熄火操作：將旋鈕開關順時針轉至(圖2)位置，火即熄滅。
4. 火力調節：按照旋鈕開關所對應的火力指示，旋轉旋鈕開關，可獲得相對應的火力。
5. 此安全裝置只防止因風或水等意外使爐火熄滅所引起的漏氣事故，不能防止其它原因所致的漏氣事故。氣體將在10-30秒內關閉。安全裝置啟動後也必需將旋鈕盡快轉回到關的位置(如圖2)，待氣體消散後才可重新點火。請勿過於依賴安全裝置，請小心使用氣體爐具。

## 清掃維護注意事項

1. 爐具表面保養：請以蘸有中性洗滌劑抹布擦拭，然後以乾布擦拭，切勿用鋼絲刷等硬物清潔。
2. 為使爐具保持正常使用與良好燃燒狀態，必須經常用刷子和鋼針疏通出火孔(槽)，清除銅芯、銅蓋、銅燃燒器上的污物，以免出火孔(槽)堵塞後產生回火而損壞爐具，切勿用水洗。
3. 經常檢查銅芯、銅蓋及銅燃燒器等是否移位或偏離；若有，必須糾正(務必放置到位)，以免意外事故的發生。

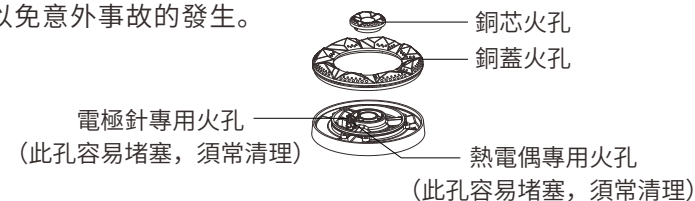

### 告用戶環境影響書

1. 產品使用的乾電池在電能耗盡後請妥善處理，避免對環境造成污染。
2. 本產品使用適合環境並易於回收的包裝材料，請認真負責地處理包裝材料可以節約原材料，減少廢料。
3. 請勿讓兒童玩耍塑膠薄膜、紙箱等包裝材料，這可能會產生窒息事故，所以請讓包裝材料遠離兒童。

## 常見故障及處理方法

故障現象	原因	處理方法
點火不靈	燃氣氣源開關未打開	先關閉爐具旋鈕開關，再將氣源閥門打開
	燃氣管路中混有空氣	反復打火排盡管內的空氣
	電極針瓷頭不乾淨	清除乾淨
	電極針與接受端距離不當	將電極針與接受端距離調至約4mm左右
	未裝電池、電池極性裝反或電力不足	正確裝上電池或更換新電池
燃氣點著火 鬆手後又熄滅	銅芯、銅蓋、銅燃燒器未放到位	必須將銅芯、銅蓋、銅燃燒器放置到位
	旋鈕未按壓到底	用力將旋鈕按壓(壓到底)然後鬆手
燃燒不正常 或有噪音	爐頭、火焰口堵塞	消除堵塞物
	如有其他燃燒不正常，或產品有噪音	聯絡代理商，安排合資格人士檢查

### 售後服務

若產品有其他故障，或其他不明原因，建議停止使用，立即聯絡代理商，以便安排合資格氣體人士為產品進行檢查。必須由註冊氣體裝置技工執行，而該技工已於相關的氣體工程類別註冊及受聘於註冊氣體工程承辦商。

香港總代理

嘉榮電器貿易有限公司

荃灣沙咀道57號荃運工業中心二期2樓G室 電話2421 1210